



AURO-3D[®] HOME THEATER SETUP

Installation Guidelines

Rev.: 8, Date: 2017 May 31

Contact Information

BELGIUM

Auro Technologies NV

Kievitstraat 42

B-2400 Mol

Tel: +32 14 31 43 43

info@auro-technologies.com

www.auro-3d.com

Table of Contents

1	Introduction	6
1.1	Some background on the Auro-3D® format	6
1.2	History	6
1.3	Some background on “Sound in 3D”	9
1.4	The Auro-3D® Concept.....	9
2	Auro-3D® Listening Formats	11
2.1	Auro-3D® Scalable Speaker Configurations.....	12
2.2	The most popular Auro-3D® speaker configurations	14
2.2.1	Auro 9.1	14
2.2.2	Auro 10.1	14
2.2.3	Auro 11.1	15
2.2.4	Auro 13.1	16
3	Room Characteristics.....	17
3.1	Listening Room.....	17
3.1.1	Room size and shape	17
3.1.2	Acoustics	17
3.2	Setup Diagrams.....	18
3.3	Speaker Positioning.....	20
3.3.1	Detailed Specifications	20
3.3.2	Overview	23
3.4	Special cases	24
3.4.1	Low ceiling.....	24
3.4.2	Multiple Top Speakers.....	26
4	Speakers	27
4.1	Speaker type	27
4.1.1	Dipole speakers.....	27
4.1.2	Split Center speakers	27
4.1.3	In-ceiling speakers	27
4.2	Polarity	28
4.3	Subwoofer(s)	28
5	AV-Processor Setup.....	29
5.1	Bass Management	29
5.2	Signal Delay	29
5.3	Room Equalization.....	29

1 INTRODUCTION

Thank you for choosing *Auro-3D®* for your Home Theater installation!

This document will guide you through the setup to maximize the experience provided by your Auro-3D® installation.

1.1 Some background on the Auro-3D® format

Auro-3D® is a revolutionary new audio technology, which achieves a lifelike immersive listening experience by adding a Height layer all around the listener. Using the three orthogonal axes (x, y, z) the speaker setups reproduce true three-dimensional sound as a hemisphere all around the audience. Auro-3D® literally introduces the third dimension “Height” to movies and music, which radically transforms and augments their emotional impact. The Auro-3D® format brings the most immersive and natural 3D audio into a wide range of potential markets (Film, Home Audio, Gaming, Music, Automotive, etc...). It is the most efficient technology for true 3D sound, maintaining the highest level of audio quality and immersion that was intended by the creators. A fundamental element of the concept behind the format is **compatibility**. All Auro-3D® listening formats are mutually compatible, but they are also completely accordant with any existing workflows, delivery formats and available bandwidth, as well as with the existing standards for stereo and 5.1 Surround.

The Auro-3D® speaker layouts represent the most efficient setup for real 3D Sound reproduction. Combined with the groundbreaking Auro-Codec® technology they present an all-in-one and end-to-end solution for the easy integration of the third dimension into all audio markets. High Resolution audio is delivered in all channels, without the need for extra bandwidth or a new delivery format (which is a standard problem for Surround content in lossless formats). The result is a totally new listening experience, producing a much more natural sound which evokes a heightened emotional response.

1.2 History

In 2006, Auro-3D® was introduced by the inventor Wilfried Van Baelen (CEO Galaxy Studios and Auro Technologies) with demonstrations of his Auro 9.1 and Auro 10.1 speaker layouts at the AES convention in Paris and San Francisco during the “Surround Sound with Height” workshops. That same year he brought together a team of engineers to develop his groundbreaking concept of the Auro-Codec® audio codec and Auro-Matic® up-mixing technology. The Auro-Codec® allows for mixing and ‘un-mixing’ in PCM (the uncompressed audio format), delivering High Resolution Audio in all encoded and decoded channels. The spectacular Auro-Matic® algorithm turns all legacy content – whether it is Mono, Stereo or Surround Sound - into a natural, immersive sound field over either one of the Auro-3D® speaker layouts, or even a standard pair of headphones.

During the 4-year development of the Auro-3D® Technology Suite, many tests were performed to define the most efficient way a natural sound field can be reproduced all around the listener. The goal was to produce a scalable solution for various room sizes and shapes, whilst taking maximum compatibility and preservation of the artistic intent into account. The resulting Auro-3D® concept achieves an all-in-one solution for all markets. It delivers the most efficient immersive sound format, without compromising the original vision of the creators and at the same time maintaining the original studio-grade quality. This totally new experience brings the consumer much closer to the on-screen action on an almost subconscious level. In 2010 the Auro-3D® format, the Auro-Codec® and Auro-Matic® Pro plug-ins as well as the Auro 11.1 cinematic speaker layout were finally launched at the AES Spatial Convention in Tokyo.

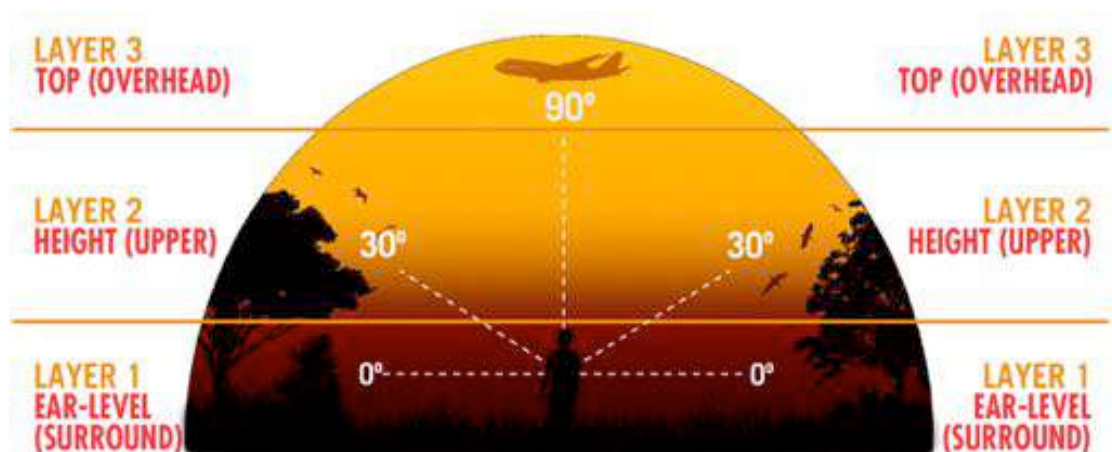

Instead of using the term 'Surround Sound with Height', Wilfried introduced the term **Immersive Sound** as a more all-round description. Therefore it is not dependent on the technology being either channel- or object based. The use of an object-based technology provides no guarantee to great immersive sound; it all depends on the way it is has been implemented by creatives.

The Auro-3D® format is a hybrid format, which uses both channel- and object-based technology (the latter called AuroMax®), depending on the final goal. In order to create a proper immersive experience using object-based technology, typically more than 20 individually amplified speakers are required.

Auro-3D® first revolutionized the cinema industry in 2011 with the support of Barco, world leader in professional digital cinema projectors, aiming to deliver the best audio-visual experience to their customers.

George Lucas, famously stated that *sound* comprises at least 50% of the movie experience – the addition of sound to a moving image evokes a higher emotional response from the

audience. As a result the film industry has always been on the forefront of audio technology, always pushing the envelope in the field of sound reproduction. It propelled the introduction of Stereo and Surround Sound, as well as the introduction of digital audio with Dolby Digital, DTS...

In the summer of 2011, the worldwide leading post production facility Skywalker Sound installed the first Auro-3D® Studio System in their MIX A Studios. Only a few months later, on November 1, 2011, George Lucas announced that his next film “Red Tails” would be released in Auro 11.1 as the first film in history with Immersive Sound. The reactions of exhibitors were overwhelming, and immediately there was a sizable demand to install the Auro 11.1 system in various theaters all over the world. Leading competitors followed suit with the announcement of their own 3D audio solutions, generating a new worldwide wave of “Immersive Sound” in the industry. After 150 years of sound recording and reproduction, the Auro-3D® format succeeded in adding the final and missing “Height” dimension all around the listener.

Several solutions have been proposed to the market, but few of them fulfill the cross-media requirements of the entire contemporary multi-media space: 3D audio for movies, broadcast, music, events, gaming with the quality, flexibility and efficiency of Auro-3D®’s unique technology.

Where does the name Auro-3D® come from?

Audire: Latin word for “to hear”

Audio: Sound related; literally means “I hear”

Aurum: Latin word for “gold” (a symbol for eternal quality and outstanding value in many cultures)

Aura: A distinctive [atmosphere](#) or [quality](#) associated with something, derived from the Ancient Greek word for “air”

AURO-3D®: the golden standard in audio that envelops the listener with sound (as if it were air)

1.3 Some background on “Sound in 3D”

The constitution of “Height”, the third dimension in sound, is not just about adding more speakers. The introduction of the vertical axis in sound recording and reproduction brings about a completely different experience for human beings compared to what they are used to hear in the horizontal plane only. There is a clearly perceivable improvement in transparency, depth and natural harmonic coloring when adding the Height Layer as a “*vertical stereo field*” in front and all around the listener. Research at Galaxy Studios (home of Auro-3D®) has led to the discovery of an ideal angle between 25° and 35° for the position of the Height layer, creating a (quadraphonic) field all around the listener to be installed above the 2D Surround layer at ear-level as defined by the ITU-standard (ITU-R BS.775). In larger home theaters or larger rooms like professional theaters, an additional third layer recreating a natural space is absolutely required to fill the gap directly above the audience. Contrary to what many people would believe, this “Voice of God” channel is not a crucial element in creating the most immersive experience - its use is actually limited to fly-overs and other special effects. The rationale behind the Auro-3D® concept is the fact that in nature, most source sounds and the most important reflections are not coming from directly above us. Human beings are therefore less sensitive for sounds coming from above. For that reason, the vertical stereo field in front and all around the listener (as defined by Auro-3D® and part of each Auro-3D® speaker layout) is key to achieve the most natural immersive sound experience. In many cases, the 3-layered Auro-3D® speaker layouts allow for a much more precise vertical localization of sources as well as their all-important reflections, something which is lacking in competitive formats using object-based technology with only 2 layers. The vertical resolution is thus a key element in achieving the most natural and immersive sound.

“The closer to a real life-like sound, the more immersive the impact of the experience”

(quote Wilfried Van Baelen, AES 2006).

1.4 The Auro-3D® Concept

A large part of what we hear is the reflections of sound around their sources. But even a million speakers will not be able to reproduce natural sound. Instead, the goal is to use a minimum amount of channels to achieve a good sound spread in the hemisphere. Every additional channel can become a possible cause for problems with phase, workflow, distribution, bandwidth etc... Therefore the goal of the Auro-3D® format is to deliver the most immersive listening experience with the minimum amount of channels/speakers. It provides a scalable solution from Auro 9.1 up to Auro 13.1 for home cinemas (more playback channels are possible using the AuroMax® system but this is usually not implemented in home cinemas).

There is a discussion about the inclusion of ceiling speakers in the layout, with the alternative suggestion of beaming systems using the ceiling as a reflective surface. However, at the 2014 CEDIA convention the very respected Dr. Floyd Tool explained that such systems are based on psycho-acoustic tricks, and thus not capable of reproducing a natural sounding space. These psycho-acoustic effects are quite easy to achieve within Surround sound systems, but this becomes much more difficult when using the vertical axis. The resulting sweet spot (the area that provides the listener with an optimal experience) is also very small. The Auro-3D® format, on the other hand, creates an even larger sweet spot than the 5.1 / 7.1 Surround standard formats can provide.



“After 150 years of sound recording and reproduction, I’m delighted that the Auro-3D® format with its unique technology has revolutionized the worldwide industry, becoming history’s first true 3D sound format for all audio markets. For a long time, the crucial role of the height dimension in sound recording and reproduction was largely underestimated. The

success of the Auro-3D® format launched a new wave of inspired creatives that bring new exciting and heightened emotional experiences to their consumers’ daily life wherever they are, in all kinds of movies, games and music. I wish all of you a lot of fun and many unique moments with your Auro-3D® home system” (Wilfried Van Baelen)

2 AURO-3D® LISTENING FORMATS

Content in Auro-3D® can be presented in various channel configurations. The table below gives an overview of the main configurations in which Auro-3D® content will be delivered through various media such as Blu-ray Disc.

The most efficient speaker layout that can reproduce a 3D space is the Auro 8.0 system : two quadraphonic layers above each other, creating a “vertical stereo field” around the listener. Adding a center channel and LFE delivers Auro 9.1 : the most efficient 3D speaker layout with 5.1 backwards compatibility. Auro 10.1 is adding the third layer (TOP) and is the most efficient 3-layered speaker layout with 5.1 backwards compatibility.







Configuration	Icon	L	R	C	LFE	Ls	Rs	Lb	Rb	HL	HR	HC	T	HLs	HRs
Auro 8.0		x	x			x	x			x	x			x	x
Auro 9.1		x	x	x	x	x	x			x	x			x	x
Auro 10.1		x	x	x	x	x	x			x	x		x	x	x
Auro 11.1		x	x	x	x	x	x			x	x	x	x	x	x
Auro 11.1 (7+4)		x	x	x	x	x	x	x	x	x	x			x	x
Auro 13.1		x	x	x	x	x	x	x	x	x	x	x	x	x	x

Table 1 - Auro-3D® Content Configurations

If the installed speaker system has fewer speakers than the number of channels provided in the content, all Auro-3D® equipped systems are capable of automatically down-mixing the content to the installed setup.

Note that the Auro-3D® format has speaker layouts with much more playback channels (e.g. AuroMax 22.1 and AuroMax 26.1) based on the Auro-3D® speaker layouts described above but used for its AuroMax® system. AuroMax® is the newest member of the Auro-3D® format and combines its Object-Based technology (up to 64 channels) with Auro-3D®’s unique 3-layered channel based technology (up to Auro 13.1 beds). AuroMax® delivers the highest resolution and sound precision of all immersive sound systems on the market. With at least 20 individually amplified channels, it makes sense to use Object-Based technology to further

enhance the spatial resolution. But such large amount of speakers and channels are typically only found in professional cinema theaters or in High End home cinemas.

For more info about AuroMax®, please contact us at info@auro-technologies.com.

2.1 Auro-3D® Scalable Speaker Configurations

Depending on the size of the room and some practicalities, different but fully compatible speaker layouts were designed based on 100% backwards compatibility with the Surround standard. The Auro-3D® Engine, which is integrated in each Auro-3D® compatible AV-Processor, handles a perfect playback of each Auro-3D® master over every single one of those speaker layouts.

The Auro-3D® format supports various speaker setups for the reproduction of 3D, immersive sound. The table below shows all supported speaker configurations and their main use cases. Mind that, although all these configurations are supported, some of them are not capable of fully reproducing the immersive experience as intended by the format.

Configuration	L	R	C	Ls	Rs	Lb	Rb	HL	HR	HC	T	HLs	HRs	Example Listening Situation
Auro 8.x	x	x		x	x			x	x			x	x	No Center speaker. Used in some classical music recordings. Not recommended.
Auro 9.x	x	x	x	x	x			x	x			x	x	Standard Auro-3D® configuration for home environments. Recommended minimal setup for full Auro-3D® experience.
Auro 10.x	x	x	x	x	x			x	x		x	x	x	Extended Auro-3D® configuration for home environments with Top
Auro 10.x -C	x	x		x	x			x	x		x	x	x	Extended Auro-3D® configuration for home environments with Top, without Center. Not recommended.
Auro 10.x (5+5)	x	x	x	x	x			x	x	x		x	x	Auro-3D® configuration for professional and high-end environments without Top. Not recommended.
Auro 11.x	x	x	x	x	x			x	x	x	x	x	x	Standard Auro-3D® configuration for professional and high-end environments. Recommended layout for larger home cinema rooms.

Configuration	L	R	C	Ls	Rs	Lb	Rb	HL	HR	HC	T	HLs	HRs	Example Listening Situation
Auro 11.x -C	x	x		x	x			x	x	x	x	x	x	Auro-3D® configuration for professional and high-end environments, without Center. Not recommended.
Auro 11.x (7+4)	x	x	x	x	x	x	x	x	x			x	x	Extended Auro-3D® configuration for home environments with support for 7.1 Surround.
Auro 11.x (7+4) -C	x	x		x	x	x	x	x	x			x	x	Extended Auro-3D® configuration for home environments with support for 7.1 Surround, without Center. Not recommended.
Auro 13.x	x	x	x	x	x	x	x	x	x	x	x	x	x	Extended Auro-3D® configuration for professional and high-end environments. Recommended layout for large home cinema rooms with support for 7.1 Surround.
Auro 13.x -C	x	x		x	x	x	x	x	x	x	x	x	x	Extended Auro-3D® configuration for professional and high-end environments, without Center. Not recommended.
Auro 13.x -T	x	x	x	x	x	x	x	x	x	x		x	x	Extended Auro-3D® configuration for professional and high-end environments, without Top. Not recommended.

Table 2 - Auro-3D® Speaker Configurations

2.2 The most popular Auro-3D® speaker configurations

2.2.1 Auro 9.1

Auro 9.1 is the most efficient 2-layered speaker layout able to reproduce a 3D space and 5.1 compatible. Its “vertical stereo field” around the listener, which is part of each Auro-3D® speaker layout, is key to get a natural immersive sound experience.

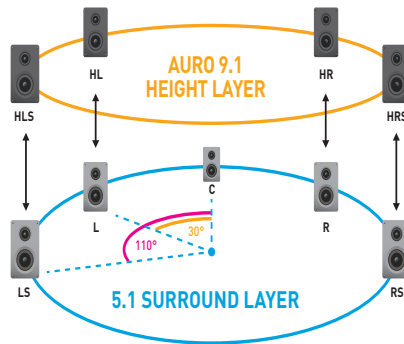

2.2.2 Auro 10.1

Auro 10.1 is the most efficient 3-layered speaker layout to reproduce a 3D space with 5.1 compatibility. To achieve a natural spread of sound in the vertical axis in larger spaces, at least 3 layers are needed in order to have a hemispherical coherent sound field.

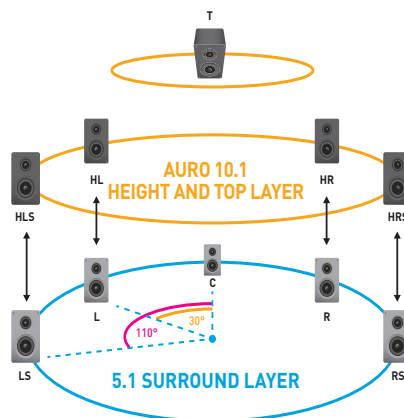

2.2.3 Auro 11.1

Auro 11.1 is Auro-3D®’s very popular speaker layout used in cinema theaters. It is based on Auro 10.1 with the addition of a Height Center channel, providing a total of 6 front channels spread over 2 vertical planes, delivering the best screen sound experience of all sound formats on the market. Auro 11.1 became Barco’s favorite choice because it delivers the most immersive sound experience in small as well as large cinemas in the most efficient way.

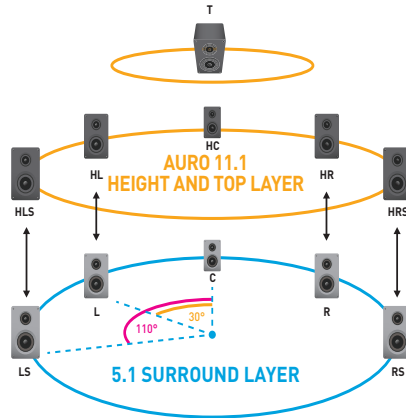

The two-layered Auro 11.1 (7+4) is the most efficient 2-layered speaker layout based on 7.1 Surround.

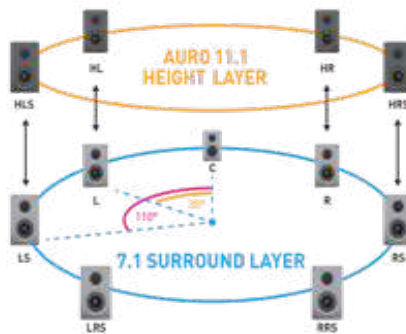

2.2.4 Auro 13.1

Auro 13.1 is the most efficient 3-layered speaker layout based on the 7.1 Surround standard including 6 screen channels distributed over 2 vertical planes (similar to the Auro 11.1 system).

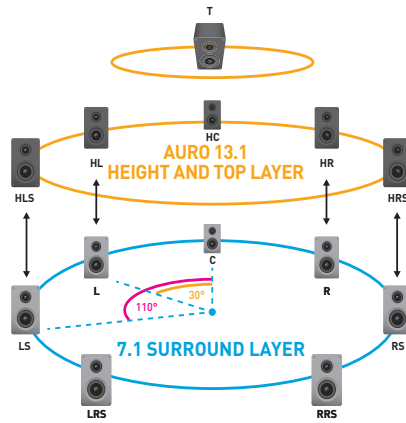

3 ROOM CHARACTERISTICS

3.1 Listening Room

Auro-3D® works in all sorts of rooms, but we would like to advice on room size and shape as well as acoustics so one can strive for the perfect listening environment.

With the introduction of the Height element in the movie and music productions, some significant differences exist between standard Stereo and Surround rooms, and Auro-compatible listening environments. Some basic design considerations are room size and geometry, acoustics, equipment, wiring, etc. Especially the room height and acoustics will be affected by the introduction of the additional speakers and other necessary equipment. It is therefore highly recommended to consult a specialized acoustician and/or architect, when retrofitting an existing home theater or building a new one.

3.1.1 Room size and shape

Room size and shape will be greatly influenced by the needs of the actual application. In any case, the room should be high enough to position the Height speakers at the correct angle compared to the distance of the speakers to the main listening position. Medium rooms are often in the advantage, because the ideal ratio between distance and angle is easier to achieve, but at the same time these rooms demonstrate some other difficulties as well. In larger rooms, items such as lighting, screen size, HVAC, etc. introduce their own challenges.

Throughout this document, specifications are targeted towards small, medium and large rooms, depending on the dimensions and number of seats. Typically, rooms with a single row of up to 4 seats with screens up to 105" are considered small rooms. Large rooms have 2 or 3 rows of seats and large screens of more that 120".

3.1.2 Acoustics

Care should be taken, both when building a new room or retrofitting an existing one, that the acoustics do not influence the performance of the system negatively. An acoustician can measure and point out problems, especially when e.g. positioning the Height speakers close to a (too) reflective ceiling or placed in corners. Such anomalies should be eliminated to ensure a proper listening environment for superb Auro-3D® productions.

3.2 Setup Diagrams

There are many possible room layouts for Auro-3D® installations. They range from smaller setups, typically configured as Auro 9.1 targeting music productions, to large home theater setups, geared for configurations up to Auro 13.1.

In all cases, a space is required that can allow for the placement of at least 9 full range (20Hz-20kHz) speakers around the main listening position, plus a subwoofer for the reproduction of the LFE (Low Frequency Effects) channel (20-120Hz).

If the use of full range speakers is not possible, please refer to section 5.1 in this document.

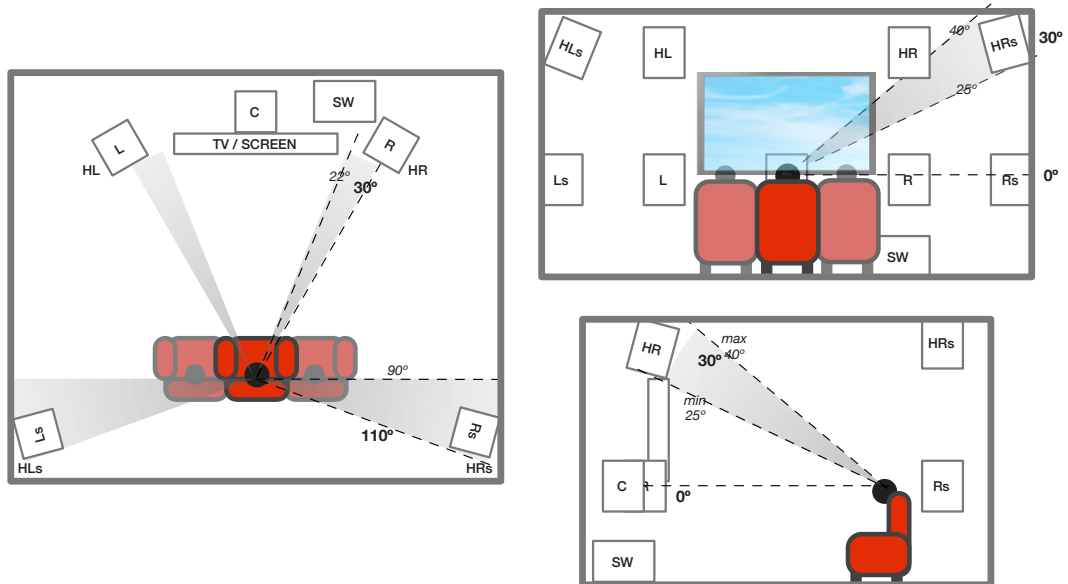

Figure 1 - Typical Auro 9.1 Speaker Setup

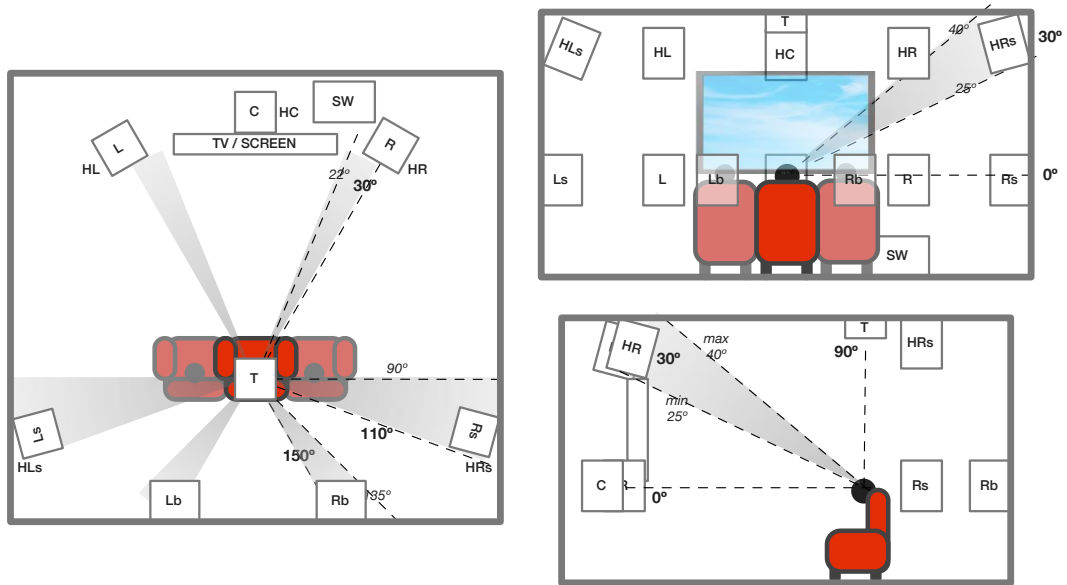

Figure 2 - Typical Auro 13.1 Speaker Setup in medium rooms

Figure 1 and Figure 2 give a schematic representation of the standard Auro 9.1 and Auro 13.1 setups for small to medium rooms. These setups use discrete channels only. For detailed information about the positioning, please see chapter 3.3.

Larger rooms typically use multiple speakers for the Surround speakers, both in the Lower and Height layer. This not only allows for a better coverage of the listening area in larger rooms, but also gives the sound the diffuse character as heard in a cinema theater.

It is advised to use the same number of Surround speakers in both the Lower and Height layer to maintain equal power and spread in both layers.

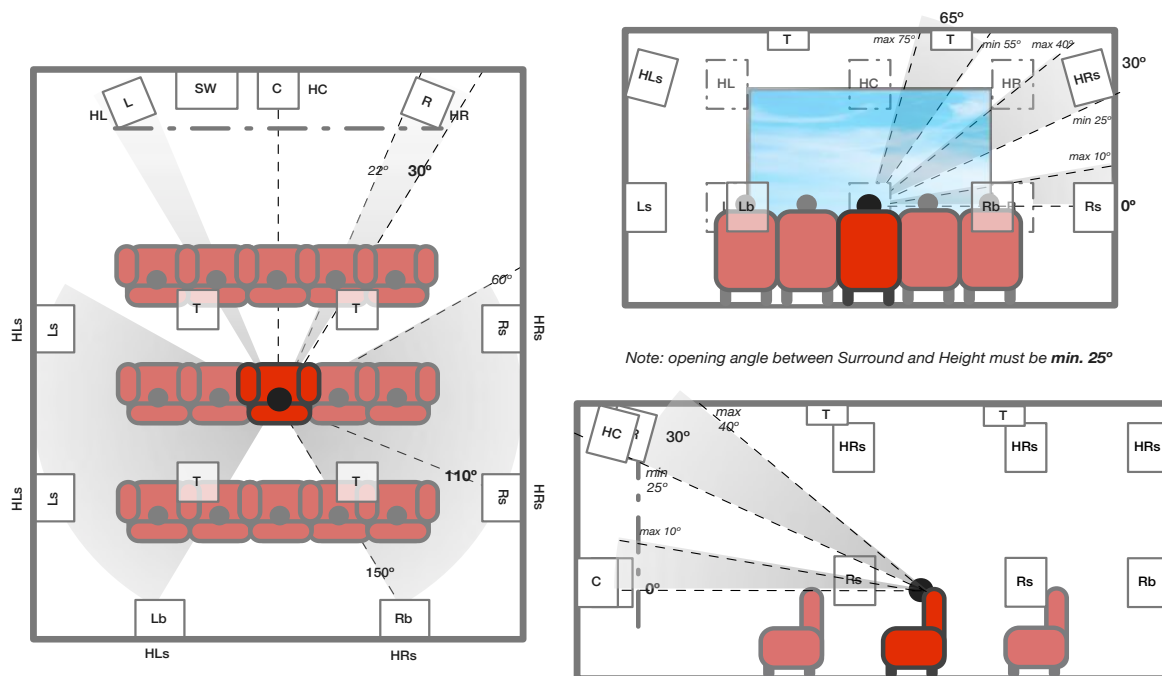

Figure 3 – Auro 13.1 Speaker Setup in a large Home Theater

3.3 Speaker Positioning

All speakers should be **equidistant** from the main listening position.

The acoustic centers of the lower speakers should be in the horizontal plane **at ear-level**. The speakers in the Height layer should be elevated to an angle of 30° and tilted in such a way that the acoustical center is aimed at the listener's head when standing. The Top speaker should be positioned right above the main listening position, at 90° of elevation, and should be pointing downwards.

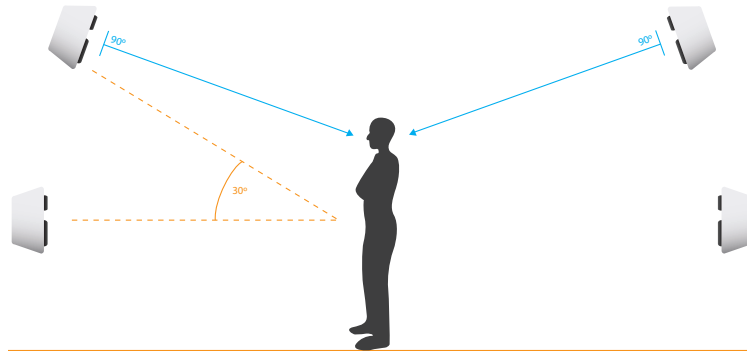

Figure 4 - Height speaker angling and Tilt

If the Center speaker needs to be positioned above or below a video monitor and as a result the acoustic centers of the front speakers are not aligned, it is important to try to position the tweeters in as close to a horizontal line as possible.

If the Center, Surround, Height and/or Top speakers are not equidistant with the L/R pair, a signal delay may be applied to obtain coincident arrival of the sound at the listening position.

3.3.1 Detailed Specifications

The specifications for an Auro-3D® listening room layout are based on the recommendations provided by the ITU-R¹ (Rec. ITU-R BS.775-2).

3.3.1.1 Auro 13.1, Auro 11.1, Auro 10.1, Auro 9.1

The Center speaker is positioned directly in front of the listener, with its acoustical center at ear-level, and is used as reference for the angles with the remaining speakers.

The Left and Right speakers are positioned at ±30° from Center, forming a 60° angle, the Surround speakers at ±110° off Center.



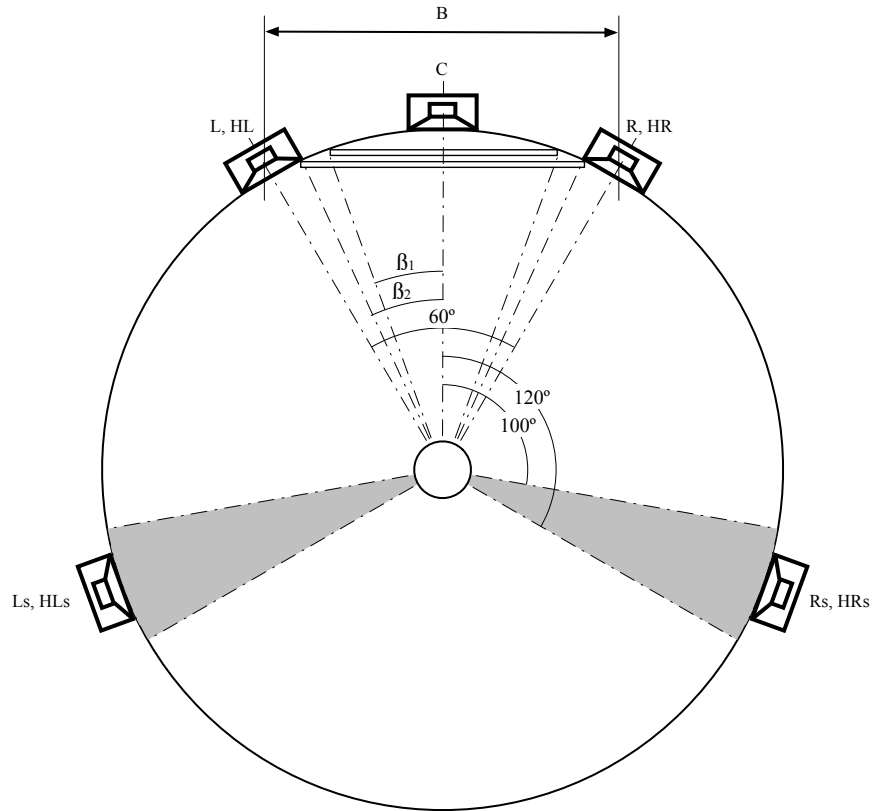

Figure 5 - Horizontal speaker positions for configurations based on 5.1 Surround

The speakers on the Height layer follow the same layout, but are elevated at an angle of 30°. The Top speaker, for configurations that have one, should be positioned right above the listener, at 90°.

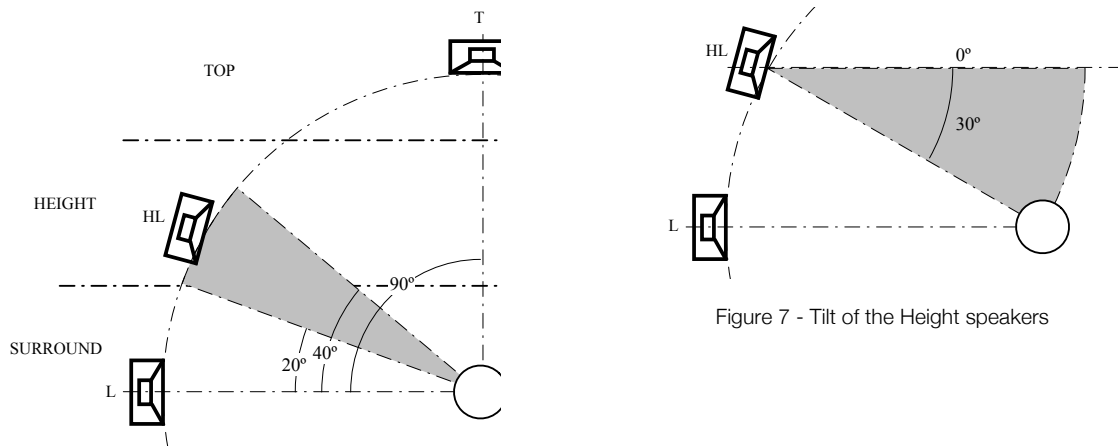

Figure 6 - Elevation angles

Figure 7 - Tilt of the Height speakers

The Surround layer is normally placed at ear level (0° elevation). However, in some larger rooms these speakers may need to be slightly elevated provide sufficient distribution of the sound power to all listening positions. In such cases, the Surround layer should be placed as low as possible, not exceeding an elevation of 10°, while maintaining a minimum angle of 25° between the Surround and Height layers at all times. This means that the Height layer should be elevated to at least 35° if the Surround layer is positioned at the maximum elevation of 10°.

3.3.1.2 Auro 13.1, Auro 11.1(7+4)

Some Auro-3D® configurations are based on a 7.1 Surround Lower layer. For these configurations, the horizontal placement of the speakers follows the ITU-R Recommendation for 7.1 Surround speaker setups in the Lower layer, and that of the 5.1 Surround setup in the Height layer.

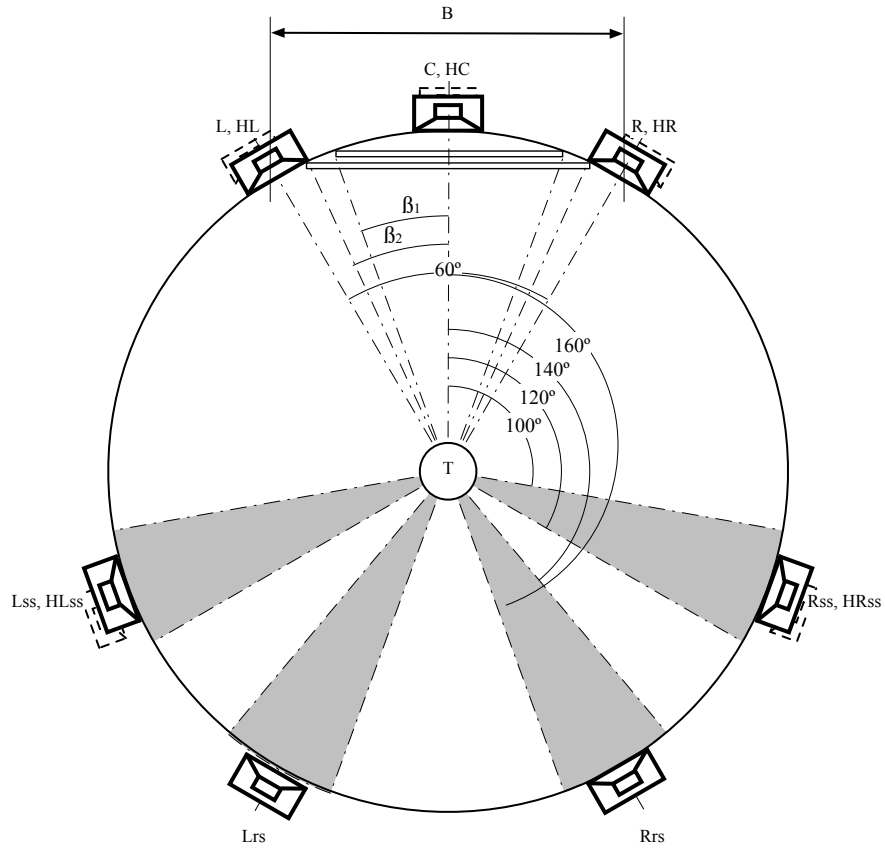

Figure 8 - Horizontal speaker positions for configurations based on 7.1 Surround

3.3.2 Overview

The following table gives an overview of the speaker positions for standard, discrete setups.

Speaker	Abbrev	Azimuth (°)			Elevation (°)		
		Min	Nom	Max	Min	Nom	Max
Left	L	-22	-30	-40	-	0	10
Center	C	-	0	-	-	0	10
Right	R	22	30	40	-	0	10
Left Surround	Ls	-90	-110	-135	-	0	10
Right Surround	Rs	90	110	135	-	0	10
Left Back	Lb	-135	-150	-155	-	0	10
Right Back	Rb	135	150	155	-	0	10
Height Left	HL	-22	-30	-40	25	30	40
Height Center	HC	-	0	-	25	30	40
Height Right	HR	22	30	-40	25	30	40
Height Left Surround	HLs	-90	-110	-135	25	30	40
Height Right Surround	HRs	90	110	135	25	30	40
Top	T	-	-	-	65	90	100

Table 3 - Normative Speaker Positions

Note that the opening angle between the Surround and Height layers should be **at least 25°** for the surround speakers and at least 22° for the Height screen channels.

3.4 Special cases

With the introduction of the Height (and Top) layers in the Auro-3D® Speaker configurations, various exceptions need to be considered for the placement of the Height speakers. The following recommendations indicate the best solution for various difficult scenarios.

3.4.1 Low ceiling

In case the ceiling height is insufficient to allow for the ideal or minimum elevation angle (and opening angle), the Height speakers can be mounted on the ceiling, slightly closer to the listening position. This should only be done in case the minimum angle of 25° cannot be achieved when placing the speakers above the Lower Screen speakers. In those cases where the Height speakers need to be shifted such that the direct distance from the Height speakers to the main listening position becomes 10% shorter than the distance from the Lower Screen channels, it is advised not to shift the speaker more inwards ($D_H \geq 0.9D_L$). This will have the advantage of maintaining the essential characteristics of the directivity of the speakers, even if this means the speakers will be mounted at angle less than 25°. With smaller distances, the speakers themselves become too noticeable, even when correctly applying time and level alignment.

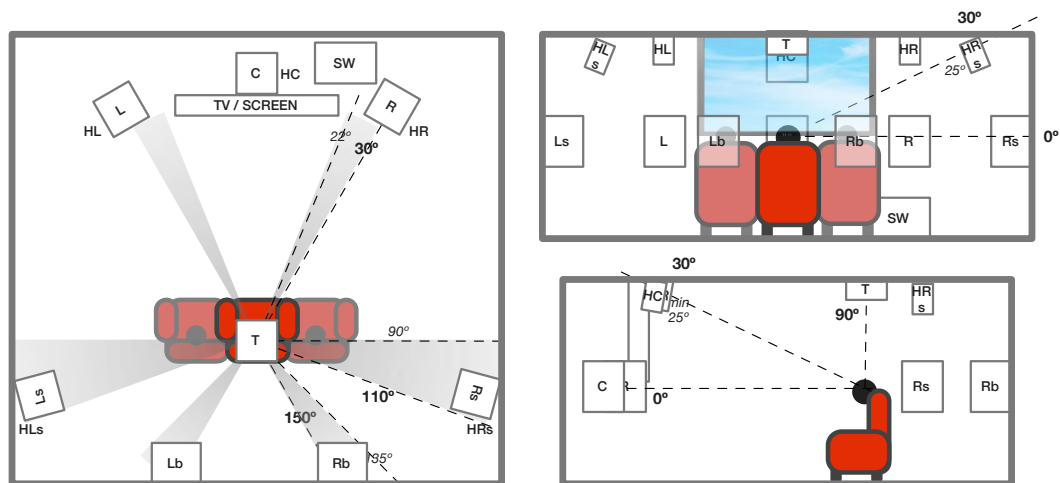

Figure 9 - Auro 13.1 Setup in small room with low ceiling

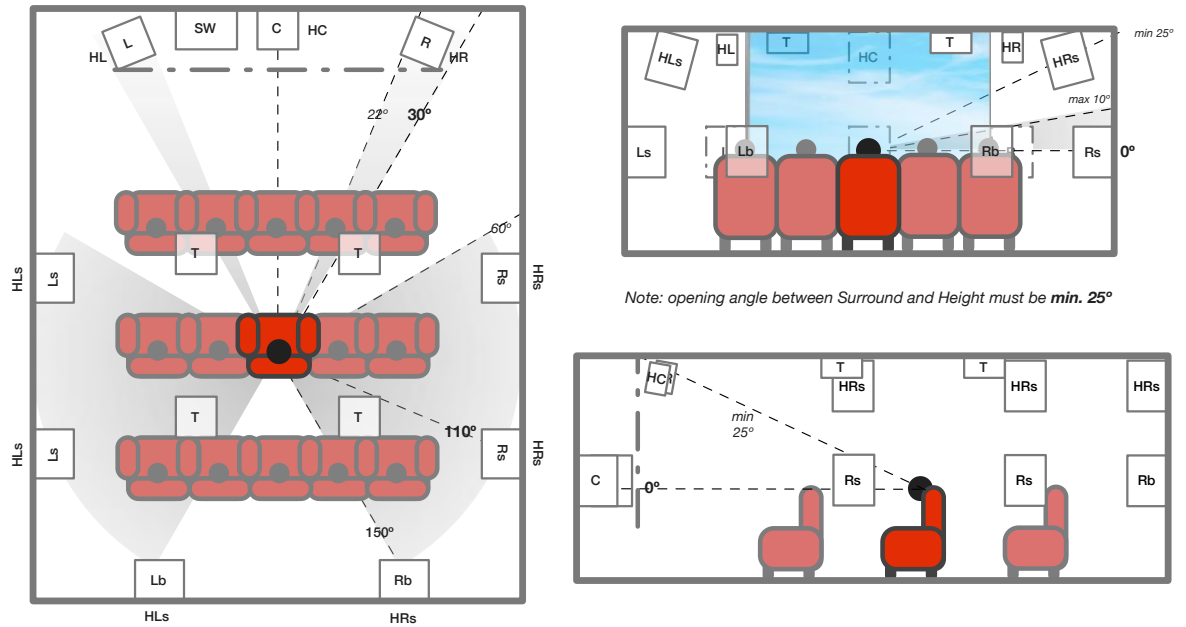

Figure 10 - Auro 13.1 Setup in large room with low ceiling

To avoid visual occlusion of the screen it can be useful to use a smaller type of speakers for the Height speakers in front of the screen. Alternatively, in-ceiling speakers with angled tweeters can be used.

It is also important to notice that for rooms with low ceilings it is highly recommended to position the Lower speakers at ear height (0°, ca. 120cm above the floor) before shifting any of the Height speakers into the room.

In summary:

1. Place the Lower speakers at ear height
2. Position the Height speakers above the Lower speakers, as high as possible to the ceiling and check the angle
3. If more than 25°, use this position.
4. If less than 25°, shift the Height speakers closer to the listening position, until an angle of 25° is achieved OR until the distance between the listening position and Height speakers (D_{H+}) is not less than 10% the distance from the Lower speakers (D_L).

3.4.2 Multiple Top Speakers

Many larger installations will benefit from the use of multiple Top speakers that are then used as an array (a single group of speakers). This will ensure an equal spread of the sound throughout the room and provide an equal experience to everyone in the room.

This is also especially true for rooms with lower ceilings, as this will also help to minimize the proximity effect of a too closely positioned ceiling speaker.

The number of speakers used in such configuration depends on the room and is done in pairs.

When using two Top speakers, they should be positioned as a L/R overhead pair at 90° elevation.

Larger rooms can benefit of using 4 or 6 Top/overhead speakers, positioned in two rows above the audience.

The following table gives some recommended angles depending on the number of speakers used.

# speakers	Row	Azimuth (°)			Elevation (°)		
		Min	Nom	Max	Min	Nom	Max
2	Top Middle	±75	±90	±115	±57,5	±65	±72,5
4	Top Front	±32,5	±45	±57,5	±57,5	±65	±72,5
	Top Rear	±127,5	±135	±142,5	±57,5	±65	±72,5
6	Top Front	±32,5	±45	±57,5	±57,5	±65	±72,5
	Top Middle	±75	±90	±115	±57,5	±65	±72,5
	Top Rear	±127,5	±135	±142,5	±57,5	±65	±72,5

Note that these speakers also provide compatibility with other Immersive Sound systems on the market.

4 SPEAKERS

4.1 Speaker type

To achieve the best tonal balance and acoustical imaging, it is recommended to use the same type of speaker for each channel. However, in case this is not possible, smaller speakers of the same product line may be used for the Surround and Center channels. This can be done in different combinations:

- All speakers equal, type A
- All speakers equal, type A, except the Front Height speakers (HL, HC, HR) a smaller type B
- All lower speakers equal, type A and all Height speakers a smaller type B
- The three lower front speakers type A, and all other speakers the smaller type B
- The L/R pair of type A and all other speakers of type B

4.1.1 Dipole speakers

Some home theater installers use dipole speakers for the Surround channels, especially when those speakers need to be positioned close to the listeners. This helps to create a more diffuse sound field without the speakers themselves becoming too obvious.

However, the addition of the Height speakers in the Auro-3D® configurations inherently eliminates these issues. The use of dipole speakers is therefore not recommended for any Auro-3D® speaker setup.

4.1.2 Split Center speakers

In some installations the space required for the Center speaker is already occupied by e.g. the television screen. The first solution is to place the speaker slightly lower, e.g. below the television screen. Sometimes 2 speakers are used and positioned next to the obstructions, creating a phantom center image between those speakers. However, the same result can be achieved by using the Front Left and Right speakers for the creation of this phantom image, especially in case the Split Center speakers need to be placed far apart from each other.

The use of Split Center speakers is not recommended for Auro-3D® speaker setups.

4.1.3 In-ceiling speakers

In-ceiling speakers can be used in rooms with lower ceilings or for esthetic reasons.

It is highly recommended to use models from the same brand/range as the lower/Surround speakers to avoid differences in sound color between the different speakers. For best results, the use of models with angled tweeters is preferred for the Front Height (HL, HC, HR) and Height Surround (HLs, HRs) speakers. For the Top speaker(s), a model without angled tweeter should be used.

4.2 Polarity

All speakers should have the same polarity. It is also highly recommended to maintain the same electrical polarity throughout the complete reproduction system.

4.3 Subwoofer(s)

It is important to include at least one subwoofer in the speaker system, which is used for the LFE channel.

When some or all of the speakers are not capable of reproducing the lowest frequencies of a soundtrack or music recording, bass management (cross-over filters, mixing of the bass with the LFE channel at the correct ratios) should be used. Various products are available that redirect the bass from any channel that is not reproduced by the speakers to the subwoofer(s).

Positioning the subwoofer(s) can be a tedious task and the positions will not be the same in all rooms. Finding the right spot(s) requires some experimentation, especially when retrofitting any existing room. While playing familiar program material with significant low frequency content, several subwoofer locations can be tried. The locations providing the smoothest bass response are the best choice for final subwoofer placement.

5 AV-PROCESSOR SETUP

5.1 Bass Management

Although all channels in all Auro-3D® configurations are specified to be full-range (20-20kHz), many home theater systems and even smaller monitoring setups will not allow for full-sized speakers in all positions. For this reason, the larger front speakers or even a dedicated subwoofer uses a bass management system to reproduce the frequencies that are otherwise lost.

With up to 14 channels in Auro 13.1, there are many possible combinations, ranging from large speakers for all channels, not requiring any bass management at all, to only small speakers and one or more subwoofers that reproduce all low frequencies.

Crossovers, subwoofer and main speakers should work together to reproduce a flat frequency response for all installed channels.

5.2 Signal Delay

It is important that the sound from each speaker not only has the correct level, but also arrives at the listening position at the right time.

In an ideal room setup, all speakers are positioned equidistant from the mixing position so those common sounds coming from two or more speakers are heard as one. If one or more speakers are not placed at the same distance, signal delay is required to achieve the intended result.

The speaker positioned furthest from the listener is used as reference point to determine the required delays. The difference in distance between this speaker and each individual speaker determines the delay time, which is calculated as approximately 3ms per meter or 1ms per foot.

5.3 Room Equalization

Various AV processors provide some means of equalization to compensate for possible problems with the room's acoustics. Some of these systems also have automatic algorithms, often using a measurements microphone in one or more positions in the room.

Whatever system is used, it is important to realize that many of these systems introduce phase problems when applying too narrow or strong equalization.

The following guidelines will help to achieve a natural sounding result.

- Avoid too many EQ bands (< 5 bands if possible)
- Limit the equalization to a frequency range below 500Hz
- Avoid gains larger than 6dB or attenuations larger than 10dB

- Use wide EQ bands as much as possible



Auro 11.1 Certified Home Cinema install at demo room of Stassen Hifi (The Netherlands).



CEDIA Award 2014 for Best Home Cinema (Dallas installation by Hometronics.)



View to the back (Top Layer speakers were already covered with acoustic transparent cloth)



Finished install: CEDIA 2014 Award Winner – Auro-3D® Certified Home Cinema Theater (Dallas)



Please contact Auro Technologies' design department for more info about:

- 1) Support for home cinema theaters with stadium seating
- 2) Auro-3D® certified home theater program
- 3) AuroMax® for High End Home Cinemas